

ENGLISH



Canon

PowerShot SD430
DIGITAL ELPH
WIRELESS

DIGITAL
IXUS
WIRELESS

Canon



Preparations

Shooting

Playback/Erasing

Menus and Settings

Wireless Connection

Basic

Camera User Guide

Please Read This First

This guide explains how to prepare the camera and use its basic features.

Flowchart and Reference Guides

The following guides are available. Refer to them as necessary according to the flowchart below.

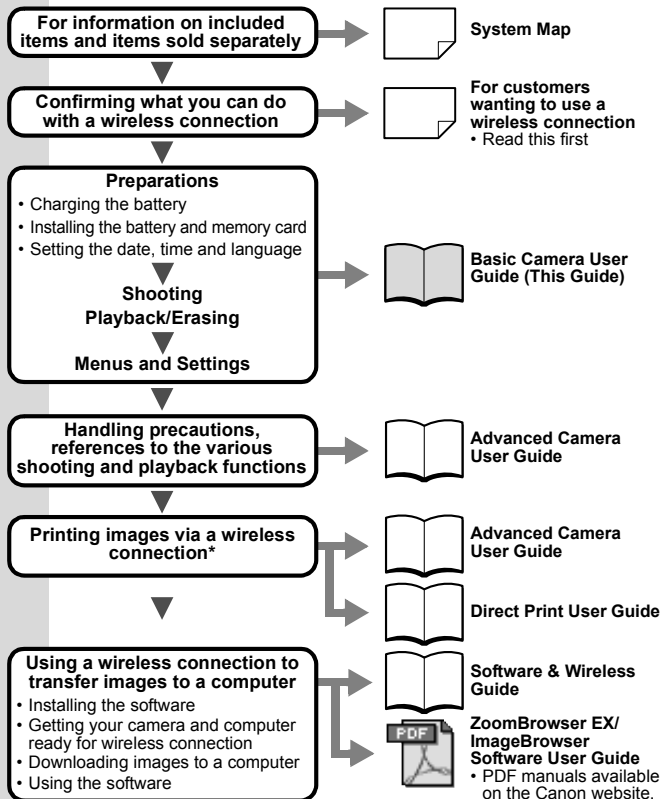

* You can also print and transfer images by using the interface cable provided to connect the camera to a printer or computer instead of using a wireless connection. Please refer to the same guide even if you wish to use the interface cable for connection.

In this guide, the *Basic Camera User Guide* is called the *Basic Guide*, and the *Advanced Camera User Guide* is called the *Advanced Guide*. Also, "battery" refers to the battery pack.

Preparations

1. Charge the Battery.

Charge the battery before use under the following circumstances.

- When using the battery for the first time.
- When the “Change the battery pack” message displays.

1. Insert the battery into the battery charger.

2. Plug the battery charger (CB-2LV) into a power outlet, or attach the power cord to the battery charger (CB-2LVE) and plug it into a power outlet.

- Battery charger model names and types vary by region.

The charge indicator will light orange while the battery is charging. It will change to green when the charge is complete. Charging takes approximately 90 minutes.

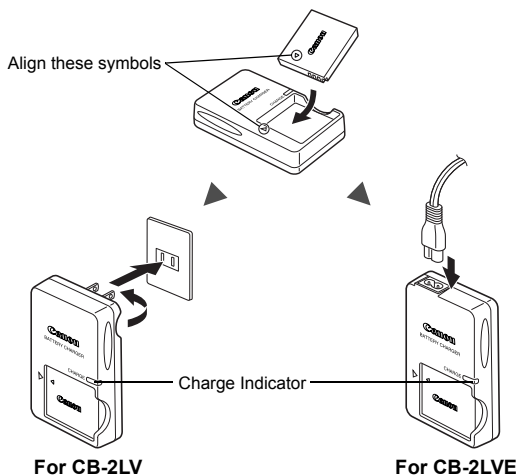

To protect the battery and prolong its life, do not charge it for longer than 24 hours continuously.

➔ See the *Advanced Guide: Battery Handling* (p. 119).

2. Install the Battery.

1. Slide the memory card slot/battery cover and open it (①, ②).
2. Push the battery lock in the direction of the arrow (③) and insert the battery until it locks.

To remove the battery, push the battery lock in the direction of the arrow (③) and hold it while pulling the battery out.

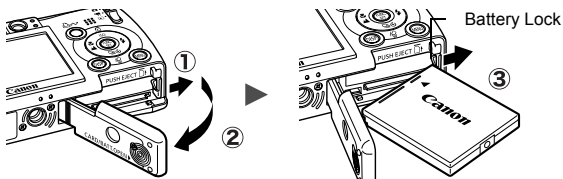

3. Insert the Memory Card.

1. Insert the memory card until it clicks into place.
2. Close the memory card slot/battery cover (①, ②).

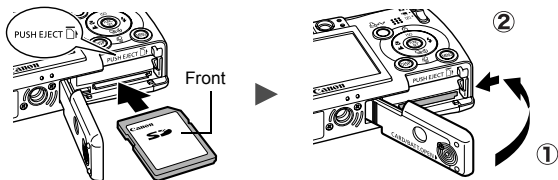

Ensure that the memory card is correctly oriented before inserting it in the camera. It may damage the camera if inserted incorrectly.

➔ See the *Advanced Guide: Handling the Memory Card* (p. 121).

➔ See the *Advanced Guide: Formatting Memory Cards* (p. 28).

■ To Remove the Memory Card

Push the memory card with your finger or the toggle on the wrist strap until the memory card clicks and then release it.

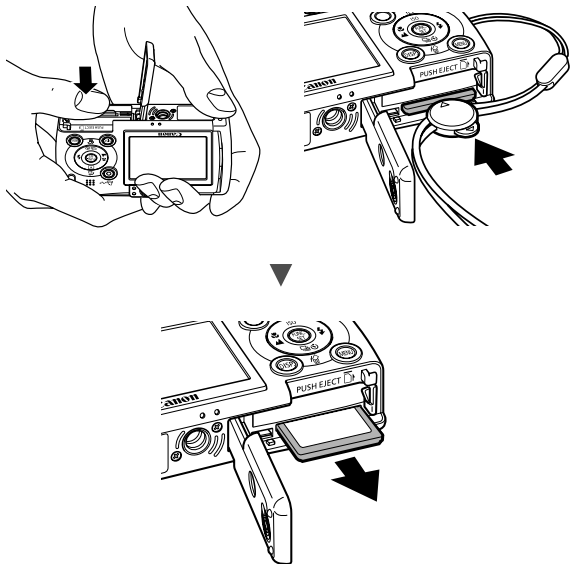

You can use SD* memory cards and MultiMediaCards with this camera. These cards are collectively called memory cards in this guide.

*SD stands for Secure Digital, a copyright protection system.

First Time Settings

■ Setting the Date/Time

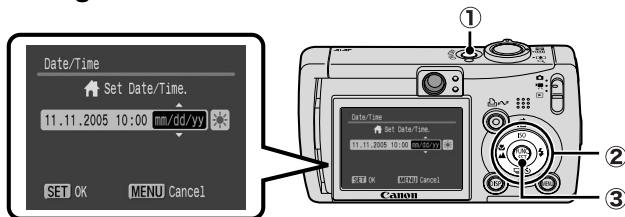

1. Press the power button (①).
2. Use the ◀ or ▶ button to select an item and the ▲ or ▼ button to change its value (②).
To set the daylight saving option, use the ▲ or ▼ button to display ☀.
3. Confirm that the correct time is displayed and press the FUNC./SET button (③).

The date and time can also be set in the Set up menu (p. 13).



- A rechargeable lithium battery is built into the camera to save such settings as the date/time. This battery charges when the main battery is in the camera. When you purchase the camera, place the main battery in it for approximately four hours or use AC Adapter Kit ACK-DC10 (sold separately) to charge the lithium battery. It will charge even if the camera is turned off.
- The date/time settings may be lost after approximately three weeks if you remove the main battery. Reset the date/time settings if this occurs.

➔ See the *Advanced Guide*: Setting the World Clock (p. 29).

■ Setting the Display Language

1. Slide the mode switch to ▶ (playback).
2. Hold down the FUNC./SET button and press the MENU button.
3. Use the ▲, ▼, ◀ or ▶ button to select a language and press the FUNC./SET button.

The display language can also be set in the Set up menu (p. 13).

Shooting

1. Press the power button.

The start-up sound will play and the start-up image will display in the LCD monitor.

- Pressing the power button again turns the power off.
- To switch to the setting that mutes all sounds (except for the warning sound), press and hold the **DISP.** button while pressing the power button.

Power Button

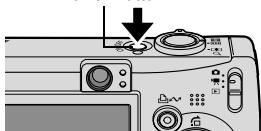



➔ See the *Advanced Guide: Using the LCD Monitor* (p. 19).

➔ See the *Advanced Guide: Power Saving Function* (p. 27).

➔ See the *Advanced Guide: Set up Menu* (p. 34).

➔ See the *Advanced Guide: My Camera Menu* (p. 36).

2. Set the shooting mode to (auto).

1. Slide the mode switch to  (Rec.) (①).
2. Press the **FUNC./SET** button (②) and use the **←** or **→** button (③) to select  (auto).
3. Press the **FUNC./SET** button (④).

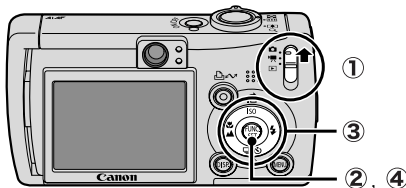

3. Aim the camera at the subject.

4. Focus and shoot.

1. Press the shutter button halfway to focus.

When the camera focuses, the camera beeps twice and the indicator lights green.

Indicators

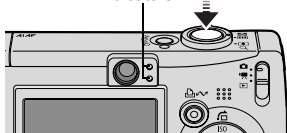

2. Press the shutter button fully to shoot.

The shutter sound will play and the image will record. The indicator will blink green while the image is recorded to the memory card.

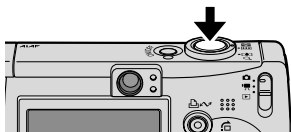

- ➔ See Basic Shooting Functions (p. 6).
- ➔ See the *Advanced Guide: Indicators* (p. 26).
- ➔ See the *Advanced Guide* for the various shooting methods available.

Reviewing an Image Right After Shooting

After a shot is taken, the image appears in the LCD monitor for approximately 2 seconds.

You can continue to display images regardless of the review duration setting with the following procedures.

- Keeping the shutter button pressed after a shot.
- Pressing the **FUNC./SET** button while the image is displayed in the LCD monitor.

To stop displaying the image, press the shutter button halfway.

- ➔ See Erasing (p. 11).
- ➔ See the *Advanced Guide: Review* (p. 33).

Basic Shooting Functions

■ Selecting a Shooting Mode

1. Slide the mode switch to (Rec.) or (Movie) (①).
2. Press the **FUNC./SET** button (②) and use the **←** or **→** button (③) to select a shooting mode.

For a scene mode (p. 7), select the mode (default setting) and press the **MENU** button to select the desired mode.

3. Press the **FUNC./SET** button (④).

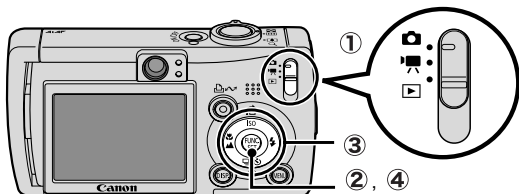

■ Shooting Modes

📷 Still Images

📷 Auto

The camera automatically selects settings.

📷 Manual

Allows you to select settings yourself, such as the exposure compensation, white balance or photo effect.

📷 Stitch Assist

Allows you to shoot overlapping images that can later be merged (stitched) to create one panoramic image on a computer. Select [Stitch Assist] from the [📷 (Rec.)] menu.

➔ See the *Advanced Guide* (p. 49).

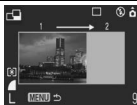

📷 Digital Macro

Allows you to shoot when the distance from the lens (at maximum wide angle) to the subject is within 3 – 10 cm (1.2 – 3.9 in.). The subject can be shown larger than in standard macro mode because the camera trims the image edges and zooms in with the digital zoom.

➔ See the *Advanced Guide* (p. 41).



📷 Portrait

Produces a soft effect when photographing people.



📷 Night Snapshot

Allows you to take snapshots of people against twilight or night backgrounds by reducing the effects of camera shake even without using a tripod.



📷 My Colors

Allows you to change the image colors easily with 9 modes.

➔ See the *Advanced Guide* (p. 63).



Scene Mode

By simply selecting one of the following shooting modes, you can shoot with the most appropriate settings for the scene.

📷 Kids&Pets

Allows you to capture subjects that move around, such as children and pets, without missing photo opportunities.



📷 Indoor

Prevents camera shake and maintains the subject's true color when shooting under fluorescent or tungsten lighting.



📷 Foliage

Shoots trees and leaves—such as new growth, autumn leaves or blossoms—in vivid colors.



📷 Snow

Shoots without a blue tinge and without making people appear dark against a snowy background.





Beach

Shoots without making people appear dark near water or sand where reflected sunlight is strong.



Fireworks

Captures fireworks in the sky sharply and at optimal exposure.



Movie









Movie

Shoots a movie when you press the shutter button.

You can select from four modes: [Standard], [Fast Frame Rate] suitable for sports or fast motion, [Compact] convenient for email attachments and [My Colors] which allows you to change color effects. ➔ See the *Advanced Guide* (p. 47).



- The shutter speed is slow in  mode. Always use a tripod to avoid camera shake.
- In , ,  or  mode, the ISO speed may increase and cause noise in the image depending on the scene being shot.
- In  mode, shoot with the subject 1 m (3.3 ft.) or more from the end of the lens.

Using the Zoom

1. Press the zoom lever toward or .

The zoom can be adjusted from 35 – 105 mm (focal length) in 35mm film equivalent terms.

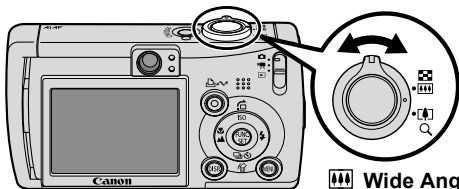

Wide Angle:

Zooms out from the subject.

Telephoto:

Zooms in on the subject.

■ Using the Flash

1. Press the button to cycle through flash settings.

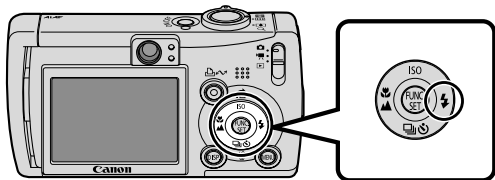

Flash settings cannot be used in some shooting modes.

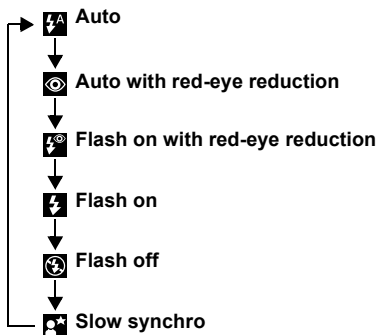

Red-eye reduction

This feature reduces the effect of light reflecting back from the eyes and making them appear red.

Slow synchro

The flash timing is adjusted to a slow shutter speed, allowing you to shoot night scenes.



You are recommended to shoot with the camera attached to a tripod or other device if the camera shake warning icon  appears.



See the *Advanced Guide: Functions Available in Each Shooting Mode* (p. 144).

■ Shooting Close-Ups/Infinity Shots

1. Press the / button to switch modes.

To cancel the macro/infinity mode: press the / button to remove or from the display.

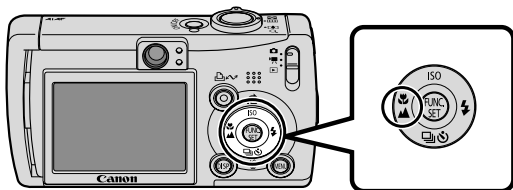

These settings cannot be set in some shooting modes.

Macro

Use this mode to shoot close-ups of flowers or small items.



Image Area at Minimum Shooting Distance from End of Lens to Subject

- Maximum wide angle setting: 37 × 27 mm (1.5 × 1.1 in.)
Minimum shooting distance: 3 cm (1.2 in.)
- Maximum telephoto setting: 108 × 81 mm (4.3 × 3.2 in.)
Minimum shooting distance: 30 cm (1.0 ft.)

Infinity



Use this mode to record subjects 3 m (9.8 ft.) or more from the end of the lens.



- Use the LCD monitor to compose close-ups in macro mode since images composed with the viewfinder may be off-center.
- The exposure may not be optimal when the flash is used in macro mode in the range of 3 – 30 cm (1.2 in. – 1.0 ft.).





See the *Advanced Guide: Functions Available in Each Shooting Mode* (p. 144).



Playback

1. Slide the mode switch to  (playback).

The last recorded image will appear in the LCD monitor.





2. Use the  or  button to display the image you wish to view.

Use the  button to move to the previous image and the  button to move the next image.

Holding the button down advances the images more rapidly, but shows them less clearly.

 See the *Advanced Guide* for the various playback methods available

Erasing

1. In the playback mode, use the  or  button to select an image to erase (①) and press the  button (②).



2. Confirm that [Erase] is selected and press the FUNC./SET button (③).

To exit instead of erasing, select [Cancel].



Please note that erased images cannot be recovered. Exercise adequate caution before erasing an image.

 See the *Advanced Guide: Erasing All Images* (p. 87).

Menus and Settings

Settings for the shooting or playback modes or such camera settings as the date/time, sounds and wireless connection are set using the FUNC., Rec., Play, Wireless, Set up or My Camera menu.

FUNC. Menu

This menu sets many of the common shooting functions.

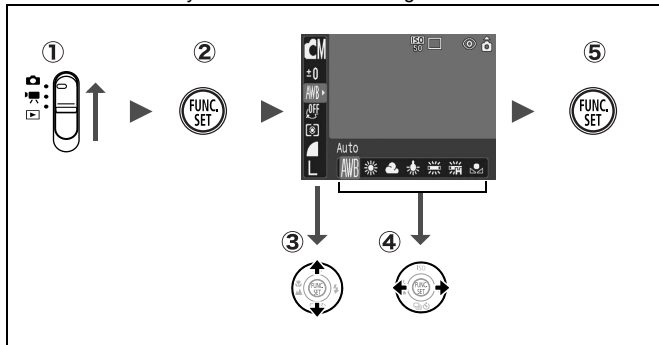

- 1 Slide the mode switch to or .
- 2 Press the FUNC./SET button.
- 3 Use the or button to select a menu item.
 - Some items may not be selectable in some shooting modes.
- 4 Use the or button to select an option for the menu item.
 - You can select further options with the **MENU** button for some options.
 - After selecting an option, you can press the shutter button to shoot immediately. After shooting, this menu will appear again, allowing you to adjust the settings easily.
- 5 Press the FUNC./SET button.

See the *Advanced Guide: Menu List* (p. 33).

Rec., Play, Wireless, Set up and My Camera Menu

Convenient settings for shooting or playback can be set with these menus.

① (MENU) →

② You can switch between menus with the ◀ or ▶ button when this part is selected.

③ ↓

④ ↓

⑤ (MENU)

- This example shows the Rec. menu.
- In playback mode, the Play menu displays.

① Press the MENU button.

② Use the ◀ or ▶ button to switch between menus.

- You can also use the zoom lever to switch between menus.

③ Use the ↑ or ↓ button to select a menu item.

- Some items may not be selectable in some shooting modes.

④ Use the ◀ or ▶ button to select an option.

- Menu items followed by an ellipsis (...) can only be set after pressing the **FUNC./SET** button to display the next menu. Press the **FUNC./SET** button again to confirm the setting.
- When selecting items from the ⚡ (Wireless) Menu, the method of operation depends on the menu item. Please confirm precise instructions on the appropriate operational procedure page.

⑤ Press the MENU button.

➔ See the *Advanced Guide: Menu List* (p. 33).

Wireless Connection

Printing

If you attach the wireless print adapter provided to a Canon *PictBridge* compliant printer, you can print your images easily via a wireless connection between the camera and the printer.

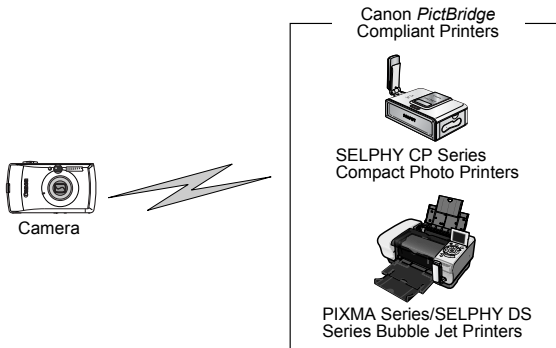

1. Attach a compact power adapter to the supplied wireless print adapter to connect it to a Canon *PictBridge* compliant printer.

- Turn the printer on.
- Slide the mode switch to  (playback) mode and turn on the camera's power.

* If you are using the compact photo printer SELPHY CP710/CP510, then there is no need to attach the compact power adapter to the wireless print adapter.

2. Press the camera's button (1).

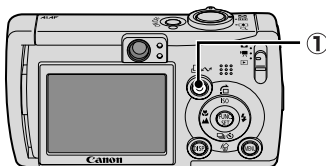

- 3.** After confirming that the target device is [1.WA-1], use the **←** or **→** button to select [Connect] (①), and press **FUNC. SET** (②).

The wireless connection will start.

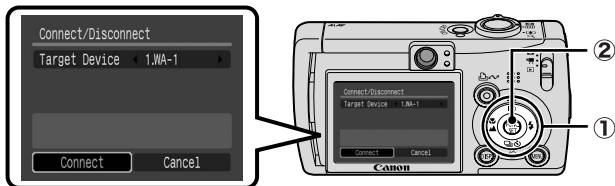

- 4.** Confirm that **[]** is displayed in the upper left of the LCD monitor (①), use the **←** or **→** button to select an image to print (②) and press the **[]** button (③).

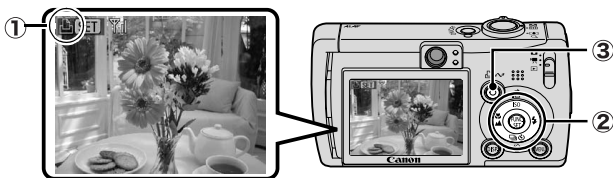

You can also print by using a cable to connect the camera to a direct print compatible printer.

Refer to the *Direct Print User Guide* for information on compatible printers and printing procedures.

➔ See the *Advanced Guide: Setting the DPOF Print Settings* (p. 88).

➔ See the *Direct Print User Guide*

Downloading Images to a Computer

The following methods can be used to download images recorded by the camera to a computer.

● **Installing the supplied software and transferring images to the computer**

- Connecting wirelessly between the camera and computer*
- Connecting the supplied interface cable to the camera and to the computer

* Connecting wirelessly between the camera and a computer is only possible with the Windows XP SP2 operating system.

● **Transferring images to the computer without installing the supplied software**

- Connecting the supplied interface cable to the camera and to the computer

● **Using a Memory Card Reader**

See the supplied *Software & Wireless Guide* for details.

* Please also see the *Windows XP and Mac OS X Users* leaflet.

Safety Precautions

Be sure to read, understand and follow the safety precautions below when using the camera, in order to prevent injury, burns or electrical shock to yourself and others.

Be sure to also read the safety precautions listed in the *Advanced Camera User Guide*.

Warnings

- Do not trigger the flash in close proximity to human or animal eyes.
- Store this equipment out of the reach of children and infants.
- Avoid dropping or subjecting the camera to severe impacts. Do not touch the flash portion of the camera if it has been damaged.
- Stop operating the equipment immediately if it emits smoke or noxious-fumes.
- Do not handle the power cord if your hands are wet.
- Use only recommended batteries and accessories.
- The battery charger and compact power adapter are designed for exclusive use with your camera. Do not use it with other products or batteries.

Caution

- Do not sit with the camera in a back pocket as it may cause the camera to malfunction or damage the LCD monitor.